

High Performance Digital Gas Mass Flow Meters & Controllers

- Measure and control gas mass flow rates up to 1000 slpm
- Pressure up to 5000 psig (333 barg)
- Ideal for OEM, industry or research applications
- True linear performance provides high accuracy and great flexibility in multiple gases
- With Dial-A-Gas® Technology, you select from up to ten pre-programmed gases or substitute your own
- Unique Pilot Module (mounted or hand-held) lets you view and change critical control functions
- All control functions are also available from your PC or workstation via supplied SmartTrak 100 software
- 316 stainless steel construction
- Small footprint and great flexibility facilitates replacement of older MFM or MFC
- Factory calibration done with primary standards directly traceable to NIST
- Proprietary frictionless-hovering direct-acting control valve technology
- Single-sided 24 VDC input power reduces installation cost and complexity
- CE approved
- Choose from multiple analog or digital signals including: RS-232, RS-485, 4-20 mA, 0-5, 1-5, 0-10 VDC
- Digital communications protocols supported
 - Modbus
 - Profibus DP
 - Foundation Fieldbus
 - Device Net (pending)

SmartTrak 100



DESCRIPTION

SmartTrak® 100 Series features unprecedented performance, user-friendly features, and flexibility. The 100 Series gives users the world's most linear sensor, smoother valve performance, more robust electronics and even more control over a wide range of functions. The result is a series of mass flow meters and controllers that demonstrates premium flow instrumentation which is easy to use.

The 100 Series is designed so that the physics are correct. Excellent performance results from a patented, inherently linear Laminar Flow Element (LFE) design, advanced platinum sensor technology, and Sierra's proprietary frictionless-hovering control valve.

The 100 Series is available with an innovative and user-friendly Pilot Module, a front-mounted or hand-held control device that allows users to Dial-A-Gas, change flow rate, modify engineering units or re-configure the instrument. With the Pilot Module, the user can set zero, span, and full scale for each of the 10 different gases independently to accommodate unexpected application or system design changes.

For the ultimate in performance, flexibility and value, SmartTrak is the smart choice.



www.sierrainstruments.com



PERFORMANCE SPECIFICATIONS

Accuracy

Standard: $\pm 1.0\%$ of full scale including linearity under calibration conditions
 $(\pm 2.0\%$ of full scale for 100M from 201-300 slpm)

Dial-A-Gas

$\pm 1.0\%$ of full scale in all 10 standard gases (see chart below)

Repeatability

$\pm 0.2\%$ of full scale

Temperature Coefficient

$\pm 0.025\%$ of full scale per $^{\circ}\text{F}$ ($\pm 0.05\%$ of full scale per $^{\circ}\text{C}$), or better

Pressure Coefficient

$\pm 0.01\%$ of full scale per psi ($\pm 0.15\%$ of full scale per bar), or better

Response Time

2 seconds (typical) to within $\pm 2\%$ of final value (includes settling time), faster or slower available upon request (controllers only).

OPERATION SPECIFICATIONS

Mass Flow Rates

100L Low Flow: 0 -10 sccm to 0 -50 slpm
 C100L High Pressure: 100 sccm to 20 slpm
 100M Medium Flow: 0-20 to 0-300 slpm
 100H High Flow: 0-100 to 0-1000 slpm (higher flows available)
 Flow ranges specified are for an equivalent flow of nitrogen at 760 mm Hg and 21 $^{\circ}\text{C}$ (70 $^{\circ}\text{F}$); other ranges in other units are available (e.g., nlpm, scfh, nm³/h, kg/h)

For measuring or controlling flows below 5 sccm, please consider Sierra's MicroTrak™ 101.

For measuring or controlling flows above 1000 slpm, please consider Sierra's MaxTrak 180.

High pressure unit should be used for pressures from 500 to 5000 psig (34.5 to 333 barg).

Gases

Measures and controls all clean gases including corrosives and toxics; specify when ordering.

The following ten gases make up the Dial-A-Gas® feature of every SmartTrak instrument; up to nine alternate gases may be substituted.

Dial-A-Gas Flow Rates				
Gas	Max Flow Rate (slpm) Low Flow Size	Max Flow Rate (slpm) High Pressure	Max Flow Rate (slpm) Medium Flow Size	Max Flow Rate (slpm) High Flow Size
Air	50	20	300	1000
Argon (Ar)	69.9	29	419.4	1398
Carbon Dioxide (CO ₂)	36.8	15	221.1	737
Carbon Monoxide (CO)	50.1	20	300.6	1002
Methane (CH ₄)	37.7	15	226.2	754
Helium (He)	69.9	29	419.7	1399
Hydrogen (H ₂)	50	20	300.3	1001
Oxygen (O ₂)	49.9	20	299.4	998
Nitrogen (N ₂)	50.1	20	300.6	1002
Nitrous Oxide (N ₂ O)	35.8	15	214.8	716

Gas and Ambient Temperature

32 to 122 $^{\circ}\text{F}$ (0 to 50 $^{\circ}\text{C}$)

Standard Gas Pressure

500 psig (34.5 barg) maximum, burst tested to 750 psig (51.7 barg)

High Pressure

5000 psig (333 barg) maximum, burst tested to 7500 psig (500 barg)

Leak Integrity

5 X 10⁻⁹ atm cc/sec of helium or better

Power Requirements

(ripple should not exceed 100 mV peak-to-peak)

For Mass Flow Meters:

15-24 VDC $\pm 10\%$, (230 mA, regulated)

For Mass Flow Controllers:

C100L: 24 VDC $\pm 10\%$ (500 mA, regulated)

C100L High Pressure: 24 VDC $\pm 10\%$ (800 mA, regulated)

C100M: 24 VDC $\pm 10\%$, (800 mA, regulated)

C100H: 24 VDC $\pm 10\%$, (1260 mA, regulated)

Control Range For Controllers

2–100% of full scale flow; automatic shut-off at 1.9%.

Output Signal

Analog:

Linear 4–20 mA, 500 ohms maximum loop resistance and one of the following (user selectable):

Linear 0–5 VDC, 1000 ohms minimum load resistance

Linear 0-10 VDC, 1000 ohms minimum load resistance

Linear 1-5 VDC, 1000 ohms minimum load resistance

Command Signal

Analog (choice of one):

Linear 4–20 mA, 0–5 VDC, 0-10 VDC, 1-5 VDC

Wetted Material

316 stainless steel or equivalent; 416 stainless steel;

Viton "O"-rings and valve seat standard;

other elastomers are available (consult factory)

High Pressure Version: Viton "O"-rings and polyamide valve seat

DIGITAL COMMUNICATION

RS-232 standard, RS-485 optional

Profibus DP

Modbus

Foundation Fieldbus

DeviceNet (pending)

RS-485 communication with Modbus RTU protocol allows digital multi-drop networks

Available with optional LCD display

Internal gas flow totalizer with adjustable pulse output

Two digital output relays and one analog input can be configured by user with MODBUS or included software for a wide variety of process controls

Pressure Drop Across a Meter

Pressure must be above the values in the table below. Note that pressure increases with flow rate.

Minimum Pressure Drop for Air, Mass Flow Meters					
Flow Rate (slpm)	Pressure Drop in PSI (mbar)				
	Low Flow ¼ inch fittings (Standard)	Low Flow 3/8 inch fittings (Optional)	Medium Flow 3/8 or ½ inch fittings	High Flow Small Bore (100H) (std up to 500 slpm) ½ comp fittings	High Flow Large Bore (H1, H2) (std 501-1000 slpm) ¾ comp fittings
0.1	0.36 (24.5)	N/A	N/A	N/A	N/A
0.5	0.36 (24.5)	N/A	N/A	N/A	N/A
1	0.37 (25.4)	N/A	N/A	N/A	N/A
10	0.46 (31.7)	0.41 (28.6)	N/A	N/A	N/A
20	0.66 (45.7)	0.47 (32.7)	0.5 (34)	N/A	N/A
30	N/A	0.59 (40.9)	0.5 (34)	N/A	N/A
40	N/A	0.77 (53.3)	0.5 (34)	N/A	N/A
50	N/A	1.00 (68)	0.5 (34)	N/A	N/A
100	N/A	N/A	1.0 (68)	1.0 (68)	0.5 (34)
150	N/A	N/A	2.0 (136)	1.2 (81.6)	0.5 (34)
200	N/A	N/A	3.0 (204)	1.5 (102)	0.5 (34)
250	N/A	N/A	4.0 (272)	1.8 (122.4)	0.5 (34)
300	N/A	N/A	5.5 (374)	2 (136)	0.6 (40.8)
350	N/A	N/A	N/A	2.5 (170)	0.7 (47.6)
400	N/A	N/A	N/A	3 (204)	0.9 (61.2)
450	N/A	N/A	N/A	3.5 (238)	1.1 (74.8)
500	N/A	N/A	N/A	4 (272)	1.3 (88.4)
750	N/A	N/A	N/A	6 (408)*	3.0 (204)
1000	N/A	N/A	N/A	10 (680)*	5.0 (340)

Note: Tested at 21°C, outlet at ambient pressure

*Larger fittings recommended for these flow rates, as small fittings reduce overall performance

Differential Pressure Requirement for Controllers

Minimum Differential Pressure Requirement for Air, Mass Flow Controllers					
Flow Rate (slpm)	Pressure Drop in PSI (mbar)				
	Low Flow ¼ inch fittings (Standard)	Low Flow 3/8 inch fittings (Optional)	Medium Flow 3/8 or ½ inch fittings	High Flow Small Bore (100H) (std up to 500 slpm) ½ comp fittings	High Flow Large Bore (H1, H2) (std 501-1000 slpm) ¾ comp fittings
0.1	1 (68)	1 (68)	N/A	N/A	N/A
1	1.5 (102)	1.28 (87)	N/A	N/A	N/A
10	6 (408)	3.8 (258)	N/A	N/A	N/A
20	12 (816)	6.6 (449)	1 (68)	N/A	N/A
30	15 (1020)	9.4 (639)	1.2 (82)	N/A	N/A
40	30 (2040)	12.2 (830)	1.6 (110)	N/A	N/A
50	40 (2720)	15 (1020)	2 (136)	N/A	N/A
100	N/A	N/A	5 (340)	1.5 (102)	1.0 (68)
150	N/A	N/A	10 (680)	2 (136)	1.0 (68)
200	N/A	N/A	15 (1020)	4.5 (306)	1.0 (68)
250	N/A	N/A	20 (1360)	5.5 (374)	1.5 (102)
300	N/A	N/A	25 (1700)	6.5 (442)	2.0 (136)
350	N/A	N/A	N/A	8.5 (578)	3.0 (204)
400	N/A	N/A	N/A	10.5 (714)	4.0 (272)
450	N/A	N/A	N/A	13 (884)	5.0 (340)
500	N/A	N/A	N/A	15 (1020)	6.0 (408)
750	N/A	N/A	N/A	N/A	15 (1020)
1000	N/A	N/A	N/A	N/A	20 (1360)

Note: Tested at 21°C, outlet at ambient pressure

*Larger fittings recommended for these flow rates as 1/4 inch fittings reduce overall performance;



SmartTrak 100

SmartTrak 100 with Compod

SmartTrak 100 High Pressure

Hand-Held Pilot Module

PHYSICAL DIMENSIONS

All dimensions are in inches with (mm) in brackets. Certified drawings are available on request.

Fittings	Dimension L						
	Length with Fittings in Inches (mm)						
	C100L, M100L	C100M	M100M 100 High Pressure	M100H	M100H1, H2	C100H	C100H, H2
1/8 compression	4.84 (123)	NA	NA	NA	NA	NA	NA
1/4 compression	5.02 (127)	6.52 (167)	6.02 (154)	NA	NA	NA	NA
3/8 compression	5.14 (132)	6.64 (170)	6.14 (157)	NA	NA	NA	NA
1/2 compression	5.3 (135)	6.80 (174)	6.30 (162)	8.29 (229)	NA	10.37 (266)	NA
1/4 VCO	4.56 (117)	6.06 (155)	5.56 (143)	NA	NA	NA	NA
1/2 VCO	5.00 (128)	6.50 (167)	6.00 (154)	8.56 (220)	NA	10.01 (257)	NA
3/4 VCO	NA	NA	NA	NA	8.78 (225)	NA	11.28
1/4 VCR	4.88 (125)	6.38 (164)	5.88 (151)	NA	NA	NA	NA
1/2 VCR	5.18 (133)	6.68 (171)	6.18 (158)	8.98 (230)	NA	10.43 (267)	NA
6 mm compression	5.04 (129)	6.54 (168)	6.04 (155)	NA	NA	NA	NA
10 mm compression	5.20 (133)	6.70 (172)	6.20 (159)	NA	NA	NA	NA
12 mm compression	5.38 (138)	6.88 (176)	6.38 (164)	8.90 (228)	NA	10.35 (265)	NA
1/4 FNPT	4.85 (124)	6.35 (163)	5.85 (150)	NA	NA	NA	NA
3/8 FNPT	NA	6.50 (167)	6.00 (154)	NA	NA	NA	NA
1/2 FNPT	NA	NA	NA	9.14 (234)	NA	10.59 (272)	NA
3/4 FNPT	NA	NA	NA	NA	9.30 (238)	NA	11.80
3/4 compression	NA	NA	NA	9.24 (237)	9.18 (235)	10.69 (274)	11.68
1 inch compression	NA	NA	NA	NA	9.52 (244)	NA	12.02

All dimensions are in inches with [mm] in brackets. Certified drawings are available on request.

M100L & C100L Front View

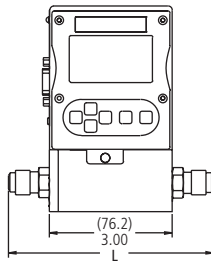

M100L & C100L Inlet View

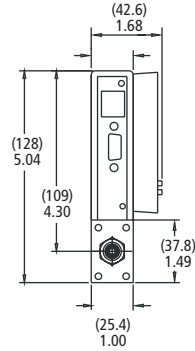

M100L & C100L Bottom View

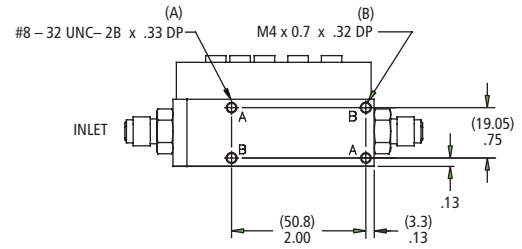

C100 High Pressure Front View

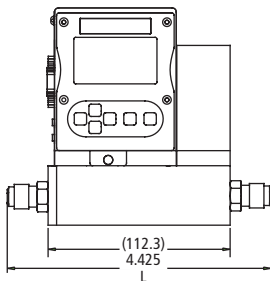

C100 High Pressure Inlet View

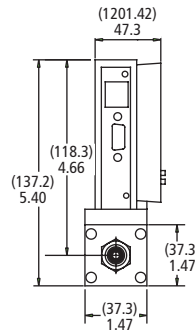

C100 High Pressure Bottom View

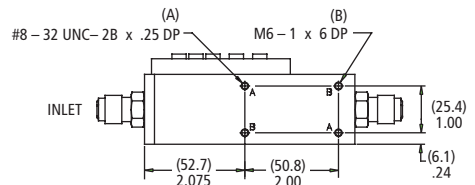

M100M Front View

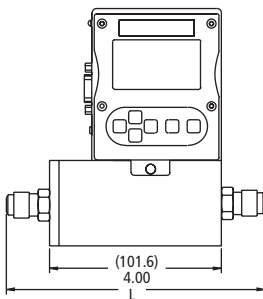

M100M Inlet View

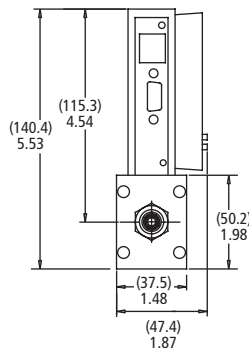

M100M Bottom View

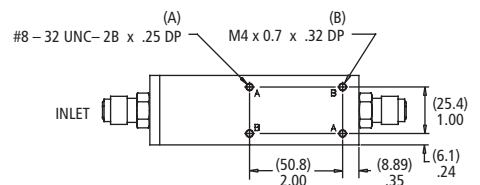

C100M Front View

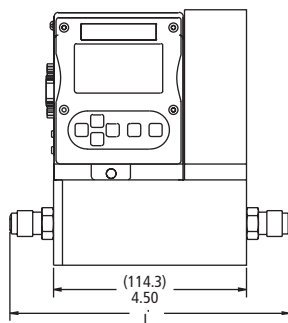

C100M Inlet View

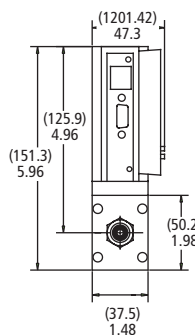

C100M Bottom View

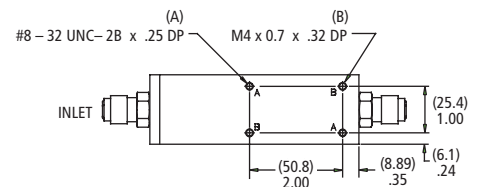

All dimensions are in inches with [mm] in brackets. Certified drawings are available on request.

M100H Front View

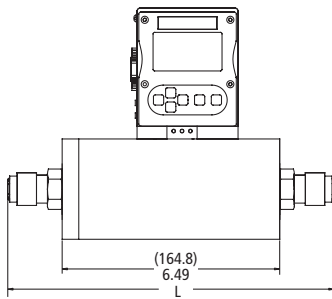

M100H Side View

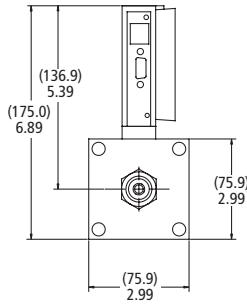

M100H Bottom View

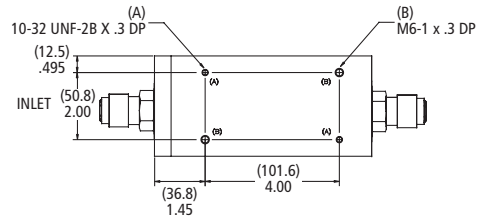

C100H Front View

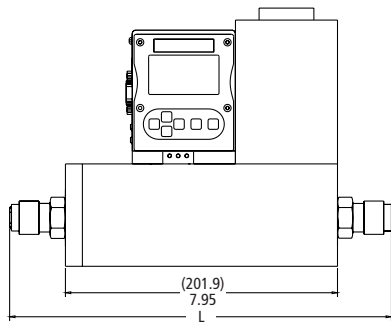

C100H Side View

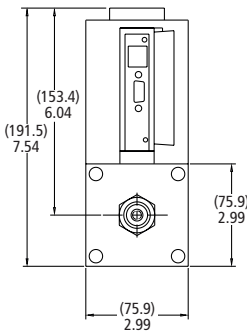

C100H Bottom View

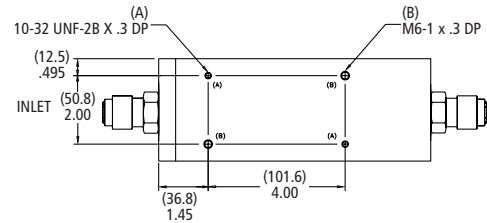

M100H1, H2 Front View

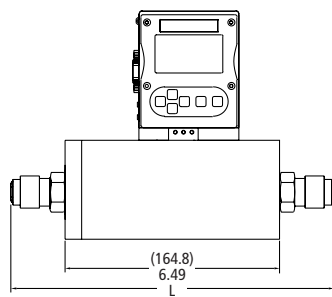

M100H1, H2 Side View

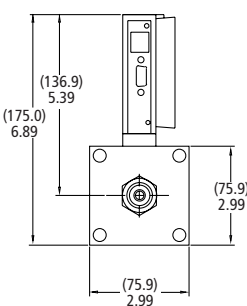

C100H1, H2 Bottom View

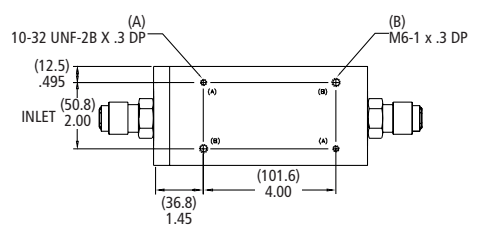

C100H1, H2 Front View

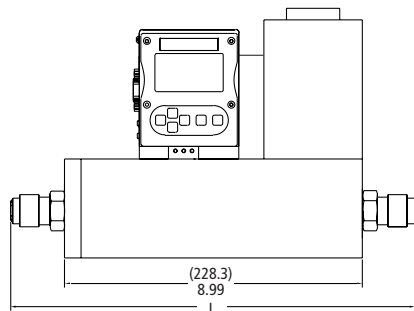

C100H1, H2 Side View

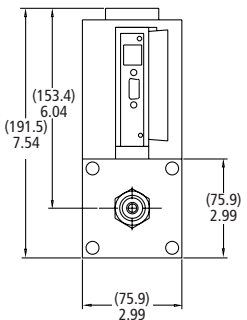

C100H1, H2 Bottom View

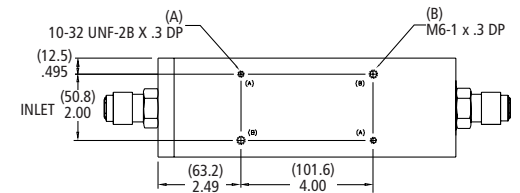

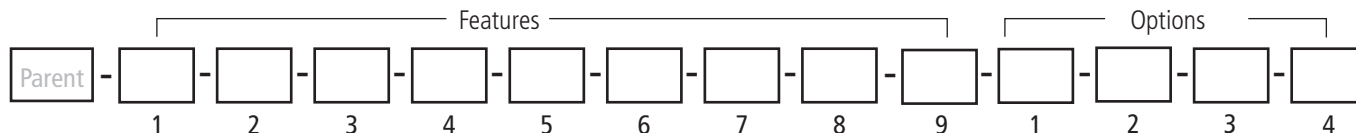

Instructions: To order a 100 please fill in each number block by selecting the codes from the corresponding features below and following pages.

Parent Number	
M100	Mass Flow Meter, Digital High Performance with Multiple Gas Capability (Dial-A-Gas®)
C100	Mass Flow Controller, Digital High Performance with Multiple Gas Capability (Dial-A-Gas®)

Feature 1: Flow Body Size*			
M101	MicroTrak mass flow meter. Full scale flow = 4 sccm, range = 0.1 to 4.0 sccm	C101	MicroTrak mass flow controller. Full scale flow = 4 sccm, range = 0.1 to 4.0 sccm.
M100L	Low flow meter: 0-10 sccm up to 0-50 slpm	C100L	Low flow controller: 0-10 sccm up to 0-50 slpm.
M100M	Medium flow meter: 0-20 slpm up to 0-200 slpm	C100M	Medium flow controller: 0-20 slpm up to 0-200 slpm
M100M1	Medium flow meter: 0-201 to 0-300 slpm. Accuracy reduced to 2.0%	C100M1	Medium flow controller: 0-201 to 0-300 slpm. Accuracy reduced to 2.0%.
M100H	High flow meter: 0-100 to 0-500 slpm full scale	C100H	High flow controller: 0-100 to 0-500 slpm
M100H1	High flow meter: 0-501 to 0-800 slpm full scale. Accuracy not affected	C100H1	High flow controller: 0-501 to 0-800 slpm full scale. Accuracy not affected
M100H2	High flow meter: 0-801 to 0-1000 slpm full scale. Accuracy not affected	C100H2	High flow controller: 0-801 to 0-1000 slpm full scale. Accuracy not affected

Note: All slpm flow ranges also available in nlpm *Flow bodies are sized for Nitrogen flow rates. Other gases must be converted to equivalent Nitrogen flow. Use K-Factor and size accordingly. **You must select Low Flow Calibration under "Options" for 0-20 sccm full scale flow range or less.

Feature 2: Pilot Module Display	
NR	No display/interface. If option 2 digital communications are selected, NR must be selected.
DD	Pilot Module Display/Interface mounted on the enclosure
RD	Remote Display Pilot Module Display/Interface. Includes 10 foot (3 meter) CAT 5 cable. Optional cables up to 50 feet (4.17 inches) may be used. May be used with digicoms but not simultaneously
CMNR**	Compod with RS-485 Modbus communication mounted on the enclosure
CMDD**	Compod with RS-485 Modbus communication and Display mounted on the enclosure
CMNRRelays	CMNR with 2 analog relays; installed in the Compod
CMDDRelays	CMDD with 2 analog relays; installed in the Compod

Note: For Digital communication options, See option 2 below
 Only one option may be selected for Feature 2.
 **You must select Low Flow Calibration under "Options" for 0-20 sccm full scale flow range or less.

Feature 4: Flow Body Elastomers	
OV1	Viton® or equivalent (standard)
OV1-F	Viton® (For phosphine only)
ON1	Neoprene®

Note: Consult factory for other elastomers.

Feature 3: Inlet / Outlet Fittings			
1	1/8-inch compression. For low flow bodies and 101. (maximum 5 slpm)	10	6 mm Compression. For low flow bodies and 101. (maximum 50 slpm)
2	1/4-inch compression (standard up to 30 slpm). For low flow bodies and 101 (maximum 50 slpm)	11	10 mm Compression. For low and medium bodies. (maximum 300 slpm)
3	3/8-inch compression (standard for 30 to 300 slpm). For low and medium bodies. (maximum 300 slpm)	12	12 mm Compression. For all flow bodies up to 500 slpm. Above 500 slpm contact factory.
4	1/2-inch compression For all flow bodies up to 500 slpm. Above 500 slpm contact factory.	13	1/4-FNPT adapter bushing (maximum 400 slpm). For low and med flow bodies only.
5	1/4-inch VCO. For low flow bodies and 101. (maximum 50 slpm)	14	3/8-FNPT. For low and med flow bodies only.
6	1/2-inch VCO. For low and medium flow bodies	15	1/2 -FNPT. For high flow bodies up to 500 slpm. Above 500 slpm contact factory.
7	3/4-inch VCO. For H1 and H2 high flow bodies only.	16	3/4-FNPT. For H1 and H2 high flow bodies only.
8	1/4-inch VCR. For low flow bodies and 101. (maximum 50 slpm)	17	3/4-inch compression. For H, H1, and H2 flow bodies only.
9	1/2-inch VCR. For all flow bodies up to 500 slpm. Above 500 slpm contact factory.	18	1-inch compression. For H1 and H2 high flow bodies only.

Feature 5: Valve Seat (MFC only)			
SV1	Viton®	SK2	Kalrez® (or equivalent for medium flow bodies)
SN1	Neoprene® (or equivalent)	SK3	Kalrez® (or equivalent for high flow bodies)
SK1	Kalrez® (or equivalent for low flow bodies)	VX1 (low flow only)	ValFlex™ required for CO2 above 50% concentration or 250 psi on C100L; available for low flow body up to 20 slpm only.

Feature 6: Input Power	
PV1M	15-24 VDC for meters (optional)
PV2	24 VDC for all instruments (standard)

Feature 7: Output Signal	
V1	0-5 VDC and 4-20 mA linear output signals (0-5 VDC not available with Compod)
V2	1-5 VDC and 4-20 mA linear output signals
V3	0-10 VDC and 4-20 mA linear output signals

Note: Alternate among V1, V2, V3 with Pilot Module display/interface or Smart-Trak Software

Feature 8: External Setpoint Signal (MFC only)			
S0	Pilot Module/RS-232 (standard for Pilot Module/digital operation)	S3	0-10 VDC , linear
S1	0-5 VDC, linear, standard for analog operation	S4	4-20 mA , linear
S2	1-5 VDC, linear	S5	0-20 mA , linear

Note: Alternate among S0, S1, S2, S3, S4 with Pilot Module display/interface or Smart-Trak Software

Feature 9: Electrical Connection			
C0	15-pin mating connector with no cable	C10	100-Analog Cable (10 foot): 15 conductor cable with D-connector on one end, fly leads on the other. 10 foot length (3 m)
C1	100-Analog Cable (1 foot): 15 conductor cable with D-connector on one end, fly leads on the other. 1 foot length (300 mm)	C 25	100-Analog Cable (25 foot): 15 conductor cable with D-connector on one end, fly leads on the other. 25 foot length (8 m)
C3	100-Analog Cable (3 foot): 15 conductor cable with D-connector on one end, fly leads on the other. 3 foot length (1 m)	C ()	100-Analog Cable (): Custom length communication cable. Specify cable length in feet in parenthesis. Maximum length 50 feet (16 meters). Fixed price any length. Note: Longer lengths available for analog models.

NOTE: All communications, both analog and digital, go through the cable on Smart-Trak 2 instruments

Option 1: Special Cals	
A1	High accuracy calibration, +/- 0.5% of FS at calibration conditions A1 Accuracy Statement Highest Accuracy Calibration; +/- 0.5% of F.S. (at operating conditions) only applies to the single gas used during calibration; Also includes 10 point linearization on actual gas. A1 Operating Conditions: Flow range: up to 50 slpm or nlpm (valid from 10 to 100% of the calibrated range) Gases: Air, Nitrogen, Helium, or Argon Pressure: up to 10.3 barg (150 psig) Temperature range: 10°C to 30°C (50°F to 86°F) Orientation: horizontal only Note: Not available for MicroTrak For other operating conditions contact factory.
GS	Gas substitution: One or more gases or mixtures may be substituted for 9 of the standard Dial-A-Gas gases. See application data sheet for specifics.
LF	Low flow calibration for all C100L and M100L; required for 0-20 sccm full scale calibrations or less; not required for 101 Series

Option 2: Digital Communications	
MB	See Compod options under Feature 2
DP	Profibus DP (NR Only)
FF	Foundation Fieldbus full device description (DD) (NR only)
DN	DeviceNet (pending)

Option 3: Certificates	
MC	Material Certificates--US Mill certs on all wetted flow body parts
CC	Certificate of Conformance

Option 4: O2 Cleaning	
O2C	O2 Cleaning. Includes certification. Product cleaned for O2 service. Inspected with Ultra-Violet light and double-bagged prior to shipment

Note: Pilot Module Not Available with Digital Communications



In Stock Products. Ship Next Day.
www.sierrainstruments.com/shop